



**Bobcat**<sup>®</sup>

*One Tough Animal.*

SKID STEER LOADERS

# S66, S76, S86

R-Series

🌐 Europe



# INTRODUCTION

# ONE TOUGH ANIMAL



## BOBCAT'S HISTORY

In 1958, Melroe Manufacturing Company introduced a compact front-end loader that evolved quickly into the M400, the world's first true skid steer loader. The company soon adopted what became the world-famous 'Bobcat' brand – and its success paved the way for the global compact equipment industry we know today.

## CONTINUOUS INNOVATION

New technologies and machines are rigorously tested in our innovation facilities to take on the toughest jobs.



## BOBCAT TODAY

With over 60 years of experience in manufacturing and continuously improving the world's most popular loaders, we've shipped over 1 million machines to the market. Our loaders are synonymous with high performance, reliability and unmatched comfort.



## OUR MISSION

We empower operators to accomplish more, while working in the toughest conditions and tightest situations. When our customers have the will, we provide the way.

# PERFORMANCE AND AGILITY MEET SMART TECH

## ► TOUGHNESS MEETS INNOVATION

Using decades of experience developing the toughest loader on the planet, we've added a host of improvements and smart technology to increase durability, boost performance, and bring first-class comfort to the all-new R-Series loaders.



LED lights with optional Premium LED with corner view

Optional side LED lights

Optimized design for greater visibility without compromising durability

Clear-view cab option for advanced visibility

Auto Ride Control option brings lift arms dampening effect

Cast steel arms for better visibility while keeping the outstanding durability

Improved cooling for improved performance and reliability

Compatible with a full range of over 100 attachments thanks to standardized Bob-Tach™ technology

Robust transmission with the proven design of the maintenance-free drive chains

Attachments are automatically leveled when moving up or down thanks to dual bucket positioning

5-block coupler with Super Flow for up to 20% boost in productivity (only for S86)

One-piece cast upgraded Bob-Tach™ with integrated debris shedding



► **AGILE AND STRONG**  
Outstanding lift capacity with high pushing and breakout forces, complemented by excellent machine agility.



► **BUILT TOUGH**  
One-piece cast steel loader arms and upgraded Bob-Tach™ with integrated debris shedding are designed for the most challenging conditions.



► **FIRST CLASS COMFORT**  
Connectivity options and soundproof cab make staying in touch easy, while longer wheel base delivers a smoother ride.



► **IMPROVED VISIBILITY**  
New cab construction is optimized for maximum visibility, further expandable by clear-view cab or rear-view camera options.

# POWER WHERE YOU NEED IT



## ▶ AGILE AND POWERFUL

Bobcat loaders are ready to conquer any challenge. They are renowned for their compact size, maneuverability, and smooth controls – but Bobcat never stops innovating. Each generation of machines is stronger, faster, and more durable than the last. The Super Flow and 5-block coupler – exclusive to the S86 – offer greater productivity and up to 20% more efficiency with advanced attachments.



# OUTSTANDING PERFORMANCE

## ▶ IMPROVED COOLING

The R-Series cooling system has been completely redesigned for optimal operation and uptime. The fan is almost 50% bigger and comes with a reversible option, increasing productivity in dirty conditions.

## ▶ INCREASED LIFTING CAPABILITIES

Thanks to the longer wheelbase and a perfect balance between weight and horsepower, the R-Series features outstanding stability and enough lift capacity for any job site.



# STEP INSIDE

## ► CLEAR-VIEW CAB

The optional clear side enclosure adds thick polycarbonate side windows with abrasion-resistant coating – maximizing your visibility and ensuring the best possible view of tracks and corners.

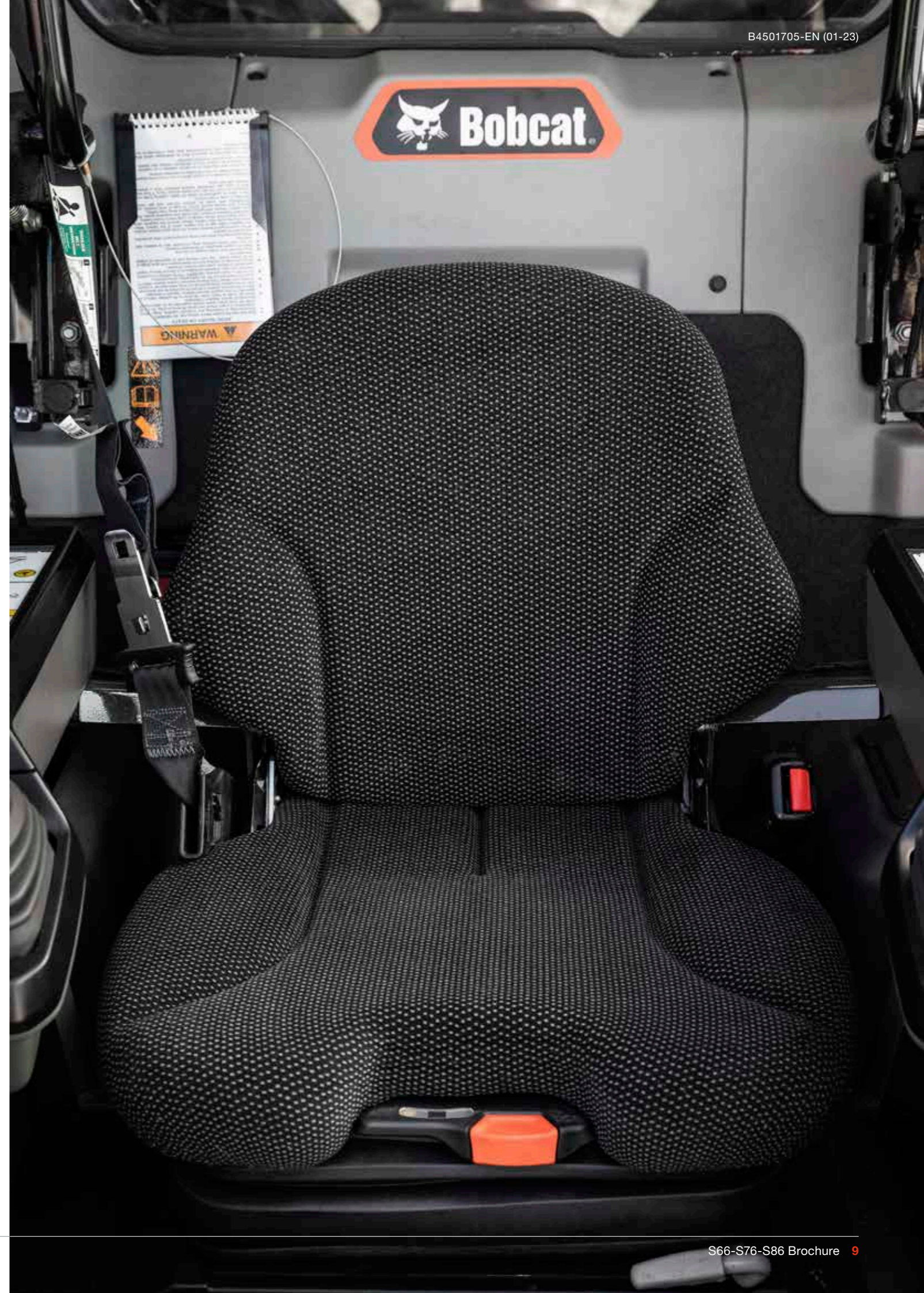

## ► INTUITIVE TOUCH CONTROLS



Take control of all settings with the optional glove-sensitive 7-inch display. The new display is waterproof and scratch resistant.

## ► ADVANCED CONNECTIVITY



Connect your phone – thanks to the integrated Bluetooth – and enhance your comfort during calls or play your favorite music.

## ► PERFECT SEAT



Comfortable suspension seat as a standard and optional cloth heated air-ride seat for maximum comfort all day – and all year – long.

# BUILT TO LAST

## ▶ OUTSTANDING UPTIME

R-Series loaders feature an extremely durable transmission with welded axle carrier and proven maintenance-free drive chain. Its unibody steel frame with integrated chain case makes the machines suitable for daily work in the most demanding environments, such as demolition sites and other industrial applications.

With a special focus on uptime, the R-Series features many small improvements that minimize maintenance and protect your machine: self-diagnostics, machine shutdown protection, battery run-down protection, cold weather protection, improved lubrication and access to greasing points, improved protection of hoses, and more.

## ▶ EXTENDED SERVICE INTERVALS

R-Series loaders feature a new fuel filter with more than double the media surface area, protecting the system even better and greatly extending the life of the filter. The improved engine design also significantly lengthens the air filter's life. This and other features allow you to improve efficiency and reduce operating costs, thanks to extended service intervals. Bobcat recommends first service after 500 hours of operation.



WIRELESS COMMUNICATIONS

## ▶ MACHINE IQ

BOBCAT® Machine IQ Wireless Communications enhances the support for your Bobcat machine.

- Durable built-in monitoring electronics
- Data is available to our machine monitoring specialist
- Maintenance is optimized for your business
- Data-driven services maximize uptime

## ▶ STANDARD WARRANTY

Bobcat develops every machine to the highest standards of quality and durability. That's why our standard warranty provides 24 months or 2 000 operating hours (whichever occurs first) of coverage.

# THERE'S NO TIME FOR DOWNTIME. STAND UP TO THE HARSHTEST CONDITIONS. DAY AFTER DAY.



## ▶ PROTECTION PLUS EXTENDED WARRANTY

Enjoy total peace of mind with Protection Plus® extended warranty. Providing the same level of protection as the standard warranty, Protection Plus also reflects different customer needs and expectations by offering a choice of durations and annual operating hours. According to your needs, you can benefit from the coverage for up to 5 years or 6 000 engine hours. And Protection Plus is transferrable – so it will likely increase your machine's resale value.



## ▶ BOBCARE PM

A long-running machine starts with proper planned maintenance, which helps protect against repair costs and unplanned failures when you're counting on your machine to work.

- Avoid risk by preventing major repairs and complete failures.
- Accomplish more by reducing downtime and increasing your productivity and profitability.

## S66

### ► COMPACT YET POWERFUL

Despite its compact footprint, the S66 offers a surprising amount of power with a rated operating capacity of 1 184 kg while running on the same reliable engine as the S76.



## S76

### ► POWER MEETS CONTROL

With a rated operating capacity of 1 367 kg, the S76 is designed to do more, even in the most demanding environments. Enjoy excellent reliability, versatility, and productivity over a wide range of applications with whatever attachment you need for the job at hand.



# CHOOSE YOUR ANIMAL

## S86

### ► BIGGER & BETTER

Reach further and do more in a powerful yet agile machine that's built to last. The S86's 1 587 kg rated operating capacity, outstanding 105 HP engine, 3 t tipping load, and Super Flow function will stand up to many years of demanding work.

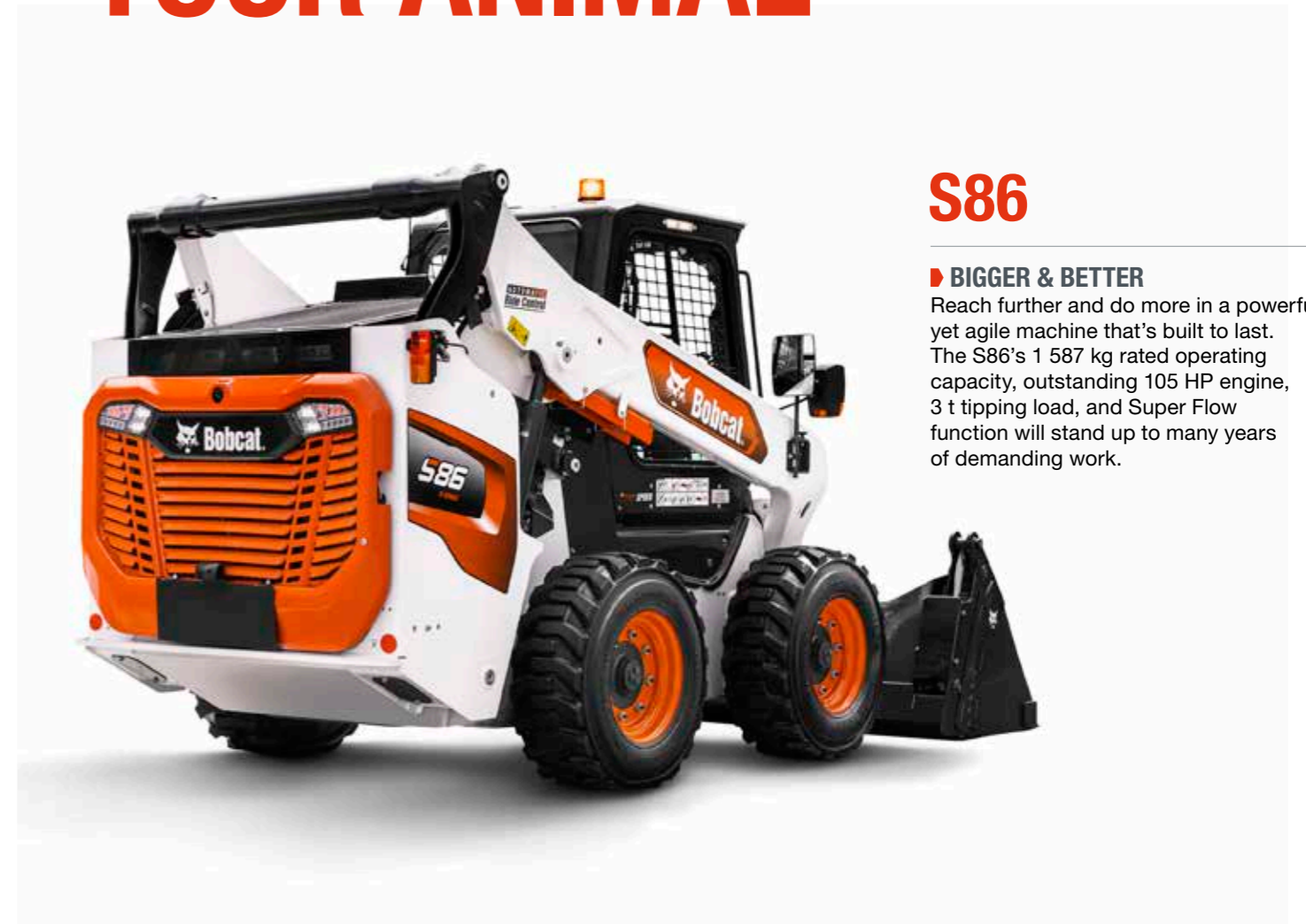

# STANDARD EQUIPMENT & OPTIONS

	S66	S76	S86
<b>CAB</b>			
3-point seat belt	✓	✓	✓
5" Deluxe instrumentation (radio ready)	✓	✓	✓
7" touch display	•	•	•
Adjustable suspension seat	✓	✓	✓
Heated cloth air ride seat with 3-point seat belt	•	•	•
Auto HVAC	•	•	•
Clear-view cab*	•	•	•
Deluxe pressurized cab* with HVAC	✓	✓	✓
Fire extinguisher kit	•	•	•
FOPS kit*	•	•	•
Key start	✓	✓	✓
Keyless kit	•	•	•
Lexan rear window kit	•	•	•
Manual hand and foot controls	•	•	•
Radio	•	•	•
Seat bar	✓	✓	✓
Selectable Joystick Controls (SJC)	✓	✓	✓
Special applications front door kit	•	•	•
<b>LIGHTS &amp; BEACON</b>			
4-way flasher kit	•	•	•
Beacon	•	•	•
LED side lighting kit	•	•	•
LED working lights front and rear	✓	✓	✓
Premium LED lights (with corner view)	•	•	•
Headlight guard kit	•	•	•
Tail light guard kit	•	•	•
Strobe	•	•	•
<b>TIRES</b>			
Heavy-duty tires	✓	✓	✓
Heavy-duty tires, offset rims	•	✓	✓
Severe duty tires	•	✓	✓
Solid flex tires	•	✓	✓
Super float tires	•	-	-

	S66	S76	S86
<b>PERFORMANCE</b>			
Attachment Control Kit	✓	✓	✓
200 lbs (90 kg) counterweight kit	•	•	•
300 lbs (136 kg) counterweight kit	•	•	•
Auto Ride Control	•	•	•
Auxiliary hydraulics: variable flow/maximum flow	✓	✓	✓
Bob-Tach™ attachment system	✓	✓	✓
Bobcat Interlock Control System (BICS)	✓	✓	✓
Dual direction bucket positioning (including ON/OFF switch)	✓	✓	✓
Engine block heater kit	•	•	•
Engine/hydraulics system shutdown	✓	✓	✓
Front axle counterweight kit	•	•	•
Five coupler auxiliary block	-	-	•
Standard flow hydraulics	-	-	✓
High flow hydraulics	✓	✓	•
Super Flow hydraulics	-	-	•
Lift arm support	✓	✓	✓
Power Bob-Tach™	•	•	•
Rear auxiliary hydraulic kit	•	•	•
Reversible fan	•	•	•
Spark arrestor muffler	✓	✓	✓
2-speed travel	✓	✓	✓
<b>MISCELLANEOUS</b>			
Backup alarm	✓	✓	✓
4-point lift kit	•	•	•
Debris seal Kit	•	•	•
Horn	✓	✓	✓
Machine IQ (telematics)	✓	✓	✓
Operating manual	✓	✓	✓
Parking brake	✓	✓	✓
Reversing camera	•	•	✓
Road kit	•	•	•
Single-point lift kit	•	•	•
Warranty: 24 months or 2 000 hours (whichever occurs first)	✓	✓	✓

\* Roll Over Protective Structure (ROPS) – meets requirements of SAE-J1040 and ISO 3471; Falling Object Protective Structure (FOPS) – meets requirements of SAE-J1043 and ISO 3449, Level I

• = option ✓ = standard - = not available or not compatible

## PERSONALIZE YOUR MACHINE

Sometimes, we all want to add a specific functionality or a personal touch to the machine. Choose from a list of comprehensive options and customize your loader to your heart's content!



Auto HVAC

Auto Ride Control

Headlight guard kit



Lexan rear window kit

LED side lighting kit

Power Bob-Tach™



Reversible fan

Reversing camera

Tail light guard kit



Clear view cab



5-block coupler for Super Flow



Premium LED lights (with corner view)



7" touch display



# MULTI-TOOL CARRIER

## BOBCAT ATTACHMENTS

Get more versatility and efficiency with Bobcat attachments.

- The largest choice of attachments in the industry.
- Match performance to your Bobcat machine.
- Work more effectively with stronger components and construction.
- Rest easy with the 12-month warranty on every genuine Bobcat attachment.

## POWERFUL ENGINE & HYDRAULIC OUTPUT

Bobcat's Super Flow feature delivers powerful hydraulic performance on several advanced attachments, with greater compatibility available soon.

Actual attachment compatibility may vary based on different machine configurations. Contact your dealer for actual attachment compatibility.



Angle brooms



Box blades



Breakers



Brush saws



Wheel saw



Concrete mixers



Drop hammers



Grapples



Landplanes



Forestry cutter



Landscape rakes



Tillers



Pallet forks



Root grapples

ATTACHMENTS	S66	S76	S76
Angle brooms	•	•	–
Auger accessories	–	–	•
Augers	•	•	•
Bale forks	•	•	–
Box blades	–	•	•
Breakers	•	•	•
Brushcat™ rotary cutters	•	•	•
Brush saws	•	•	•
Combination buckets	•	•	•
Concrete mixers	•	•	•
Construction / industrial buckets	•	•	•
Diggers	•	•	•
Dozer blades	•	•	•
Drop hammers	–	•	•
Dumping hoppers	•	•	•
Fertilizer and grain buckets	•	•	–
Flail cutters	•	•	•
Forestry cutters	–	–	•
General purpose (GP) bucket	•	•	–
Graders	•	•	•
Grapples, industrial	•	•	•
Landplanes	•	•	•
Landscape rakes	•	•	•
Laser equipment	•	•	•
Low profile buckets	•	•	•
Mixing buckets	–	•	•
Miscellaneous	–	–	•
Mowers	•	•	–
Pallet forks	•	•	–
Pallet fork accessories	–	–	•

ATTACHMENTS	S66	S76	S76
Pallet forks, hydraulic	–	–	•
Planer accessories	–	–	•
Planers	–	–	•
Rear stabilizers	–	–	•
Remote control	•	•	•
Root grapples	•	•	•
Rotary grinders	–	–	•
Sand cleaners	–	–	•
Scarifiers	•	•	•
Scrapers	•	•	•
Seeders	–	–	•
Skeleton buckets	•	•	•
Snow & light material buckets	•	•	–
Snow blades, pushers, V-blades	•	•	•
Sod layers	•	•	•
Soil conditioners	•	•	•
Spreaders	•	•	•
Steel tracks	–	•	–
Stump grinders	–	•	•
Sweepers	•	•	•
Tillers	•	•	•
Tree transplanters	–	•	•
Trench compactors	–	•	•
Trenchers	–	–	•
Utility forks	•	•	•
Utility frames	–	–	•
Vibratory rollers	•	•	•
Wheel saws	–	–	•
Whisker brooms	•	•	–
Wood chippers	•	•	•

• = compatible – = not compatible



Sweepers



Laser graders



Stump grinders



Scrapers



Snow blades



Tree transplanters

# SPECIFICATIONS

SPECIFICATIONS			
	S66	S76	S86
<b>MACHINE RATING</b>			
Tipping load (ISO 14397-1)	2 359 kg	2 722 kg	3 175 kg
Rated operating capacity (ISO 14397-1)	1 184 kg	1 367 kg	1 587 kg
Pump capacity std flow (at pump RPM)	66.5 l/min	88.1 l/min	89.3 l/min
Pump capacity high flow (at pump RPM)	101.8 l/min	114.7 l/min	138.5 l/min
Pump capacity Super Flow (at pump RPM)	-		159 l/min
System relief at quick couplers	23.8 - 24.5 MPa	23.8 - 24.5 MPa	23.8 - 24.5 MPa
Travel speed (low)	11.8 km/h	10.9 km/h	19.3 km/h
Travel speed (high)	17.3 km/h	19 km/h	10.8 km/h
Lift arm path	vertical		
<b>DIMENSIONS</b>			
Length with standard bucket	3 427 mm	3 737 mm	3 900 mm
Width over standard bucket	1 727 mm	1 880 mm	1 829 mm
Height with operator cab	2 045 mm	2 079 mm	2 111 mm
Height to bucket hinge pin	3 048 mm	3 259 mm	3 353 mm
Wheelbase	1 133 mm	1 227 mm	1 304 mm
<b>ENGINE</b>			
Make / Model	Bobcat 2.4L, 97/68 EC Stage V		D34 BSH SV, 97/68 EC Stage V
Fuel	Diesel		
Cooling	Liquid		
Power at 2 600 RPM (ISO 14396)	54.5 kW		78.7 kW
Torque at 1 800 RPM (ISO 14396)	266.3 Nm	283.9 Nm	409 Nm
Number of cylinders	4		
Displacement	2 400 cm <sup>3</sup>		3 409 cm <sup>3</sup>
Fuel tank capacity	93.7 l	120 l	
<b>WEIGHTS</b>			
Operating weight*	3 271 kg	4 038 kg	4 497 kg
Shipping weight	2 939 kg	3 597 kg	4 096 kg
<b>ENVIRONMENTAL</b>			
Operator LpA (98/37 & 474-1)	80 dB(A)		77 dB(A)
Noise level LWA (EU Directive 2000/14/EC)	103 dB(A)		101 dB(A)
Whole body vibration (ISO 2631-1) High speed	0.8 ms <sup>-2</sup>		0.59 ms <sup>-2</sup>
Hand-arm vibration (ISO 5349-1) High speed	2.8 ms <sup>-2</sup>		1.16 ms <sup>-2</sup>
<b>FORCES</b>			
Lift breakout force	2 200 daN	2 608 daN	
Tilt breakout force	2 440 daN	2 654 daN	
Push force	2 758 daN	-	
<b>CYCLE TIMES</b>			
Raise lift arms	3.8 s	3.9 s	
Lower lift arms	2.5 s	2.6 s	
Bucket rollback	1.7 s		
Bucket dump	2.3 s		

\* Base machine with bucket, operator and full fuel tank

Certain specification(s) are based on engineering calculations and are not actual measurements. Specification(s) are provided for comparison purposes only and are subject to change without notice. Specification(s) for your individual Bobcat equipment will vary based on normal variations in design, manufacturing, operating conditions, and other factors. Pictures of Bobcat units may show other than standard equipment.

# SPECIFICATIONS

## DIMENSIONS

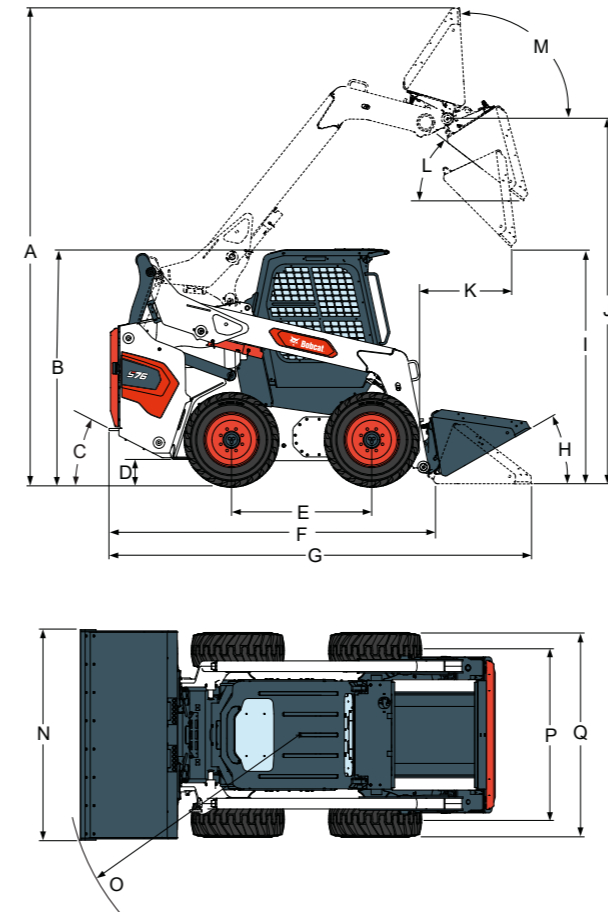

	S66	S76	S86
<b>A</b> Operating height	3 910	4 252	4 345
<b>B</b> Height with operator cab	2 045	2 079	2 111
<b>C</b> Angle of departure	25°	27°	26°
<b>D</b> Ground clearance	214	235	236
<b>E</b> Wheelbase	1 133	1 227	1 304
<b>F</b> Length without attachment	2 718	2 893	3 059
<b>G</b> Length with standard bucket	3 427	3 737	3 900
<b>H</b> Rollback at ground position	30°	30°	30°
<b>I</b> Dump height with standard bucket	2 396	2 526	2 586
<b>J</b> Height to bucket hinge pin	3 048	3 259	3 353
<b>K</b> Dump reach at maximum height	803	950	964
<b>L</b> Dump angle at maximum height	37°	37°	40°
<b>M</b> Rollback fully raised at maximum height	94°	94°	93°
<b>N</b> Width over standard bucket	1 727	1 880	1 880
<b>O</b> Turning radius with standard bucket	2 033	2 228	2 300
<b>P</b> Track, standard tires	1 407	1 584	1 592
<b>Q</b> Width over standard tires	1 642	1 829	1 829



# FINANCING OPTIONS

## 24, 36, OR 48 MONTH FINANCING\*

Take advantage of 24, 36 or 48 month financing programs starting from **0% interest** and improve your cashflow. Ask your dealer for the financing offers available.

**120 MACHINES / 150 ATTACHMENT FAMILIES / 1 TOUGH ANIMAL**



**SKID-STEER  
LOADERS**



**COMPACT TRACK  
LOADERS**

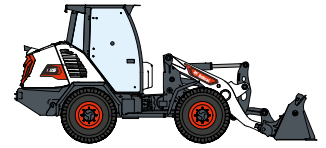

**COMPACT WHEEL  
LOADERS**

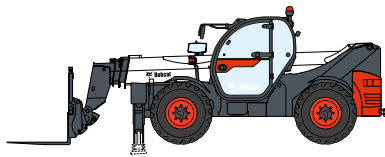

**TELEHANDLERS**

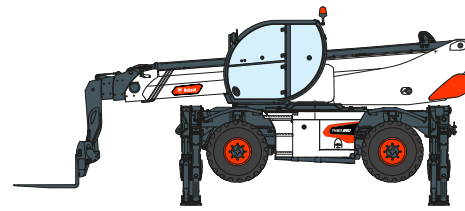

**ROTARY TELEHANDLERS**



**LIGHT COMPACTION  
EQUIPMENT**

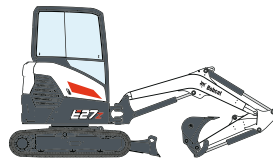

**COMPACT  
EXCAVATORS**

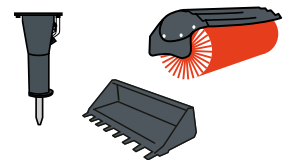

**ATTACHMENTS**



**SMALL ARTICULATED  
LOADERS**



**MINI TRACK  
LOADER**



**COMPACT  
TRACTORS**

**DOOSAN**

[www.bobcat.com](http://www.bobcat.com)

**Bobcat is a Doosan Company.** Doosan is a global leader in construction equipment, power & water solutions, engines, and engineering proudly serving customers and communities for more than a century. | Bobcat and the Bobcat logo are registered trademarks of Bobcat Company in the United States and various other countries. ©2023 Bobcat Company. All Rights Reserved.

©2023 BOBCAT B4501705-EN (01-23)



**Bobcat®**

\*Financing options may vary by country and dealer. Always ask your dealer about currently available financing options. Terms and conditions may apply.

Doosan Bobcat EMEA, U Kodelky 1810, 263 12 Dobříš, Czech Republic